

# Central Barrier in Narrow Medians

RDN 03-08

June 2018

## 1. Purpose

The purpose of this note is to provide guidance for the design, implementation and justification of safety barriers in narrow medians to address the risk of head-on crashes on rural and urban roads. Head-on crashes represent a significant proportion of fatal and serious injuries on Victorian roads.

Central barrier is presently one of the most effective treatments for reducing the likelihood and severity of head-on crashes and aligns towards providing Safe System for road users. It should be considered as one of a number of available options in progressing Towards Zero.

This treatment should be considered in the context of objectives developed as part of the overall route strategy. It is important that a treatment be selected appropriate to the class and function of the road. This should be determined when developing the scope and defining the project area.

Information in this note is applicable for greenfield and brownfield sites in rural and urban locations.

**Note, an Extended Design Domain(EDD)/Design Exception(DE) report will be required as the provision for central barrier in narrow medians currently falls outside normal design domain values<sup>1</sup>.**

This document provides recommended values for acceptance given a project provides justification for the process and values used. As this treatment is more widely used across the network, more will be learnt through monitoring about the values used in this note and their applicability to various contexts. It is anticipated that this treatment will form part of Normal Design Domain values after a period of evaluation.

This note should be read in conjunction with Austroads Guide to Road Design (AGRD) & VicRoads Supplements, [RDN 06-02](#)

<sup>1</sup> Refer to VicRoads Supplement to AGRD Part 3 "Appendix A" page 29

<sup>2</sup> "Digesting the safety effectiveness of cable barrier systems by numbers" – D. Chimba, E. Ruhazwe, S. Allen, J. Waters (29 Nov 2016)

The use of Wire Rope Safety Barrier, [RDN 06-04](#) Accepted Safety Barrier Products and [RDN 06-08](#) The use of flexible and semi-rigid Guard Fence.

## 2. Central Barrier and Narrow Medians

Studies have shown the effectiveness of median barriers in reducing fatal and serious injuries resulting from head-on crashes. One study<sup>2</sup> showed an 87% reduction in fatal median related crashes for data 3 years before and after barrier installation. Another study<sup>3</sup> shows the reduction of 12 fatal crashes to zero for a five-year period after median barrier and other safety improvements were implemented on the Centennial Highway in New Zealand.

### 2.1. Narrow Median Definition

For the purpose of this note, narrow medians are defined as medians with a width less than 6.2m measured between edge lines of opposing traffic lanes (3m offset either side of a 0.2m wide WRSB is specified as the minimum in [VicRoads RDN 06-02](#) The use of Wire Rope Safety Barrier).

## 3. Project Context and Considerations

The implementation of a central barrier in a narrow median must consider (refer to Section 4 for Design Process);

- Road class and traffic volumes<sup>4</sup>
- How the treatment fits in with planning for the route (future divided carriageway, class upgrade, vehicle overtaking strategy)
- Existing road conditions and environment (pavement width, geometry and sight distance, speed, utilities, drainage, property, accesses and intersections)

<sup>3</sup> Towards Safe System Infrastructure: A Compendium of Current Knowledge – Austroads 2018 page 87

<sup>4</sup> Refer to VicRoads Supplement to AGRD Part 3 Figure V4.6 for Class, Volume and cross section widths

- d) Maintenance considerations, including frequency of repair and available space for repair
- e) Maintenance considerations for utilities such as Telstra, Powercor, United Energy, AGL, Jemena, Citipower and AusNet Services
- f) Provision for [Heavy Vehicles including tracking](#), Over Dimensional vehicles including agricultural machinery (refer <https://www.vicroads.vic.gov.au/business-and-industry/heavy-vehicle-industry/heavy-vehicle-map-networks-in-victoria>)
- g) Emergency Services requirements, including Country Fire Authority (CFA) considerations
- h) Impact on existing overtaking opportunities and improved overtaking opportunities (i.e. 2+1 treatment)
- i) Environmental considerations, including fauna movements

**The project team and designers should undertake a risk assessment (exposure, likelihood and severity) to select a treatment based on the frequency and result of encroachments and an acceptable level of risk.**

### 3.1. Minimum length of treatment

Generally, the minimum road segment or length of treatment is 2km (including breaks for accesses and intersections). This is to provide a consistent cross section for drivers and avoids short lengths of treatment.

However, this may be reduced if there are isolated cross section constraints (such as bridges and structures) and where there is a benefit for installing the treatment in identified high risk locations, even though it may be less than the general minimum length of 2km.

### 3.2. Barrier Offsets

The offset to a central barrier has important functions;

- a) Maintain sight lines and sight distance
- b) Provides an errant vehicle recovery area
- c) Manages the dynamic deflection of a barrier and the risk of impact with vehicles in the opposing traffic lane
- d) Minimises nuisance hits requiring ongoing repair and maintenance

#### 3.2.1. Design Criteria and Median Width

Below is the median widths for each design criteria;

Design Criteria	Median Width
Normal Design Domain (NDD)	6.2m or greater
Extended Design Domain (EDD)	2.2m - 6.2m
Design Exception (DE)	Less than 2.2m

<sup>5</sup> Studies have shown that the risk of run-off road crashes into a barrier significantly decreases when a barrier is offset greater than 1.5m. Austroads Report AP-R436-14 Improving Roadside Safety Stage 4 – Interim Report page 88

#### 3.2.2. Offsets for Greenfield, State Significant Routes and Major Upgrades

The project team should always consider implementing a Normal Design Domain median width of 6.2m for greenfield sites and projects which are of state significance. Roads which require substantial pavement widening and earthworks should also consider adopting Normal Design Domain criteria.

**Where a median width of 6.2m cannot be implemented, a recommended median width of 4.2m should be adopted.**

A 4.2m median width provides a 2m offset to the barrier to;

- Contain the tested dynamic deflection of barrier systems within the median
- Allow for vehicle recovery<sup>5</sup> significantly reducing the number of nuisance hits compared with offsets of 1m or less (see Section 3.2.5)
- Discourage vehicles from breaking down in the median (compared with greater offsets)
- Avoid confusion for road users that the median may be an additional travel lane (compared with greater offsets).

A 4.2m median width balances the safety benefits and cost.

#### 3.2.3. Minimum Median Width

The minimum median width of 1.4m in Appendix A Table 1 includes a system width of 0.2m and a 0.6m barrier offset to the edge line<sup>6</sup>. A narrower width than 1.4m is possible but designers should take into consideration the effect reducing barrier offsets has on barrier deflection into the opposing traffic lane and the increase in the frequency of barrier hits. (A 0m offset is theoretically achievable and may still provide a benefit of reducing the risk of head-on crashes).

Justification for widths less than 2.2m should be provided through a risk assessment considering exposure, likelihood and severity. Reducing the median less than 2.2m may not be acceptable when traffic volumes exceed 4000 vehicles per day.

#### 3.2.4. Deflection into Opposing Traffic Lane

Austroads Guide to Road Design Part 3 Appendix E identifies the narrow median width to be 2.2m. It is preferable that the tested barrier deflection value should be contained within the median width. However, a median width of 2.2m assumes a maximum allowable deflection of 0.5m into the opposing traffic lane for a vehicle impacting a barrier.

It is acknowledged that some values for offsets and median widths in this note exceeds 0.5m of barrier deflection but it is considered that for some applications the safety benefits of

<sup>6</sup> Barrier System widths vary from 0.2m for WRSB to 0.31m for back-to-back Flexible Guard Fence. A total minimum median width of 1.4m accommodates the variation in system width and is not considered to be a non-compliance when selecting a system width greater than 0.2m and less than 0.31m

providing a central barrier in a narrow median to address the risk of head-on crashes outweigh any other associated risks<sup>7</sup>.

Typically crashes in real life occur both below and above the impact angles adopted in barrier crash testing. Research has found that fatigue related crashes occur with a vehicle drifting and leaving the carriageway at 7-8 degrees. In this scenario, it is expected that the system deflection will be less than the tested results relative to the reduced angle of impact. Other situations can result in the angles of impact being higher than that tested. A vehicle departing on a 3-4 lane carriageway from the slow lane can impact a central barrier at angles in excess of 25 degrees. For this reason, deflection of the system should be considered as a guide and never an absolute guarantee of the systems' performance.

Current methods of calculating a site-specific impact other than the tested values are imprecise due to the large number of variables that influence how a barrier responds to impact. The tested values of angles and deflection given in RDN 06-04 and the product detail sheets are based on a "worst practical case" impact scenario covering the 85<sup>th</sup> percentile for angle and speed and should be used when determining the acceptable risk of deflection into the opposing travel lane. An evaluation of this risk must be documented, including a discussion on the probability of a vehicle being present during the opposing impact.

### 3.2.5. Impact Frequency

Another important consideration when reducing offsets to barriers is the increase in frequency for the barrier to be hit. Studies have shown that increasing the inside shoulder and offset to a barrier will decrease the number of barrier impacts<sup>8</sup>. Another study showed that reducing the barrier offset from 2.5m to 1.5m for a similar section of road increased the number of hits requiring WRSB repair by 243%<sup>9</sup>. An increase in frequency of a barrier being hit will result in more regular repair, higher maintenance and whole-of-life cost as well as increase safety exposure for maintenance personnel while repairing systems.

Designers and project teams should consider offsetting barriers greater than the minimum values to reduce the likelihood of nuisance hits and minimum values should only be used in highly constrained environments when it is demonstrated that a larger offset cannot be achieved.

## 4. Design Process

This section outlines a process to be followed when developing the scope and designing a central barrier.

This process should be referenced in the Extended Design Domain or Design Exception report to justify the selected treatment and how it is appropriate to the project context.

### 4.1. Project Objectives

Key questions that the project objectives must address are;

- How does this project fit within the route strategy?
- Greenfield (or major upgrade) or Brownfield site?

### 4.2. Design Inputs

Traffic	Volume, AADT
	Number of Heavy Vehicles
	Future Traffic Growth and land use
	Peak Hourly Volumes (to determine whether overtaking opportunities need to be considered)
	Size of Heavy Vehicles for Design Vehicles at intersections and tracking of curves, Over Dimensional Vehicles
	Is there an existing crash history?
Pavement and Earthworks	Width and Depth of Existing Pavement
	Existing Pavement Design Life
	When is the pavement due for maintenance? Does the pavement need reconstruction or strengthening?
	Can the pavement be widened? What is the minimum widening width?
Geometry	Existing posted speed and Design Speed
	Existing Horizontal and Vertical Geometry
	Existing Sight Distance Conditions
	Intersections and Accesses
Utilities	What utilities are within the project area? How accurately are they located?
	If impacted, can they be relocated? What is the cost of relocation?
	What are the maintenance/access requirements?
Land	What are the existing road/property boundaries?
	Is property acquisition required? What is the cost of acquisition?
Environment	Is there any sensitive flora and fauna within the project area?
	Considerations for fauna activity

<sup>7</sup> Guidance on Median and Centreline Treatments to Reduce Head-On Casualties - Austroads 2016

<sup>8</sup> "Digesting the safety effectiveness of cable barrier systems by numbers" – D. Chimba, E. Ruhazwe, S. Allen, J. Waters (29 Nov 2016)

<sup>9</sup> "Freeway Median Barriers Whole of Life Cost" – B. Snook Main Roads WA October 2014

### 4.3. Design Process for Brownfield and Constrained Environments

This section outlines the process for implementing a central barrier into an existing cross section which is highly constrained. This approach may not be appropriate for higher class roads or state highways of greater significance where the project team should be aiming to adopt a higher standard (see Section 3.2.2).

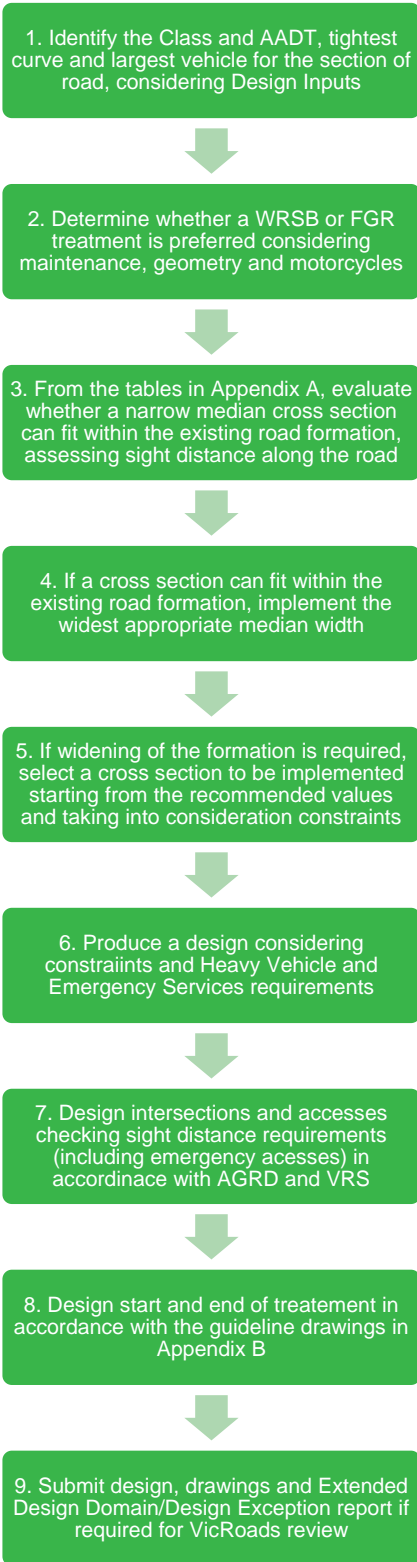

#### 4.3.1. Design Cross Section and the Existing Formation

The project team and designer must first consider the existing pavement conditions and formation width as to whether a cross section can fit within the existing pavement (sealing shoulder if required).

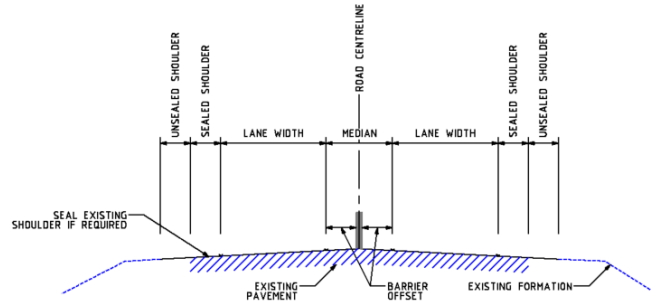

Figure 1 – Design Cross Section within the existing pavement

The existing pavement may be able to be widened and the verge sealed to accommodate the design cross section as selected from the tables in Appendix A. Localised narrowing of the design cross section may be acceptable if the required justification is provided in the Design Exception report. Heavy Vehicle access must not be restricted by a localised narrowing.

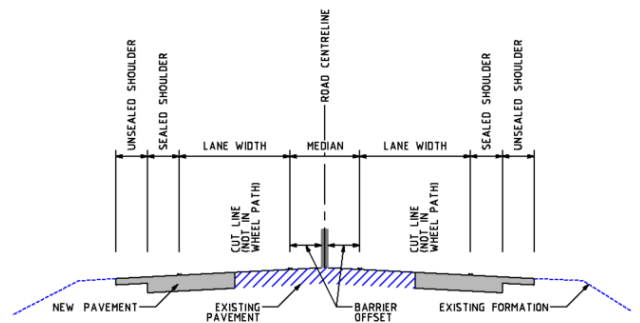

Figure 2 – Design Cross Section with pavement widening

If the design cross section cannot fit within the existing road formation, the project team and designer are to determine what additional widening of the formation is required taking into the constraints (such as environmental, utilities, drainage, geotechnical information, pavement, property acquisition, intersections and accesses).

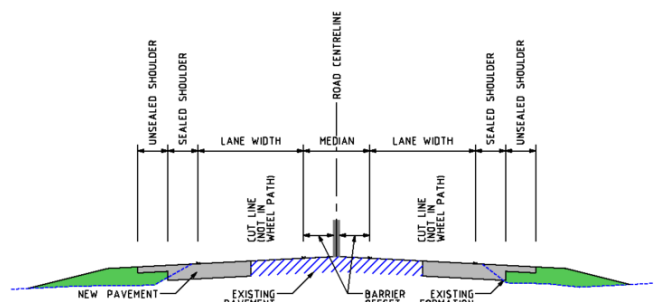

Figure 3 – Design Cross Section with formation widening



Based on current experience with projects that are underway or have been completed in Victoria, it is very unlikely that a cross section incorporating a central barrier can be retrofitted into most existing road formations. Widening of the existing formation is to be expected when implementing a central barrier in a narrow median.

Widening may be adopted on one side of the carriageway to limit impacts to utilities, existing vegetation, and changes to property accesses. Constructability advice for widening should be sought to determine the best option.

#### 4.3.2. Existing Pavement and Minimum Widening

A pavement specialist should be engaged to assess the condition of the existing pavement. It may be that the existing pavement needs reconstruction or substantial strengthening because it is reaching the end of its design life. An analysis of the existing road surface, including cross fall will determine whether any corrections need to be undertaken including improvements to superelevation.

The pavement specialist will also be able to determine the pavement design for widening including the location of the cut line and interface with the existing pavement.

A minimum width of 2m for pavement widening should be adopted. A width of less than 2m can be adopted with input from the region, constructability advice and a pavement specialist.

#### 4.4. Central Barrier and Overtaking Opportunities

The installation of a central barrier in an existing 2-lane 2-way road will remove existing opportunities for overtaking. Considerations should be given to the provision of overtaking opportunities where;

- Volumes exceed 700 vph<sup>10</sup>
- High Numbers of Heavy Vehicles
- Steep grades resulting in changes in speed

#### 4.5. Start and End of Treatment

The start and end points of the treatment (start of the transition from the existing cross section to the narrow median cross section) should have Approach Sight Distance (ASD) to ensure line marking and delineation are visible.

Design Speed	ASD Requirements	[A] Approach Length
80km/h	126m	135m
90km/h	151m	150m
100km/h	179m	170m
110km/h	209m	185m

<sup>10</sup> See Austroads Guide to Road Design Part 3 Section 9.4

The Approach Length [A] is the distance before the start of the transition to the median. This has been calculated on 6 seconds of travel.

#### 4.5.1. Transition Length

The Transition Length [T] is the length of transition from the existing cross section to the narrow median cross section.

Design Speed	1.4-2.2m Median Width	4.2m Median Width	6.2m Median Width
80km/h	45m	80m	115m
90km/h	50m	90m	130m
100km/h	55m	100m	145m
110km/h	60m	110m	160m

The Transition Length in the table above assumes that the cross section will transition equally either side of the centreline. Where the transition occurs only on one side, the Transition Length is calculated at a lateral shift of 0.6m/s.

$$\text{Transition Length [T]} = (\text{Width} / 0.6) \times \text{Speed}$$

(Width is in m; Speed is in m/s)

The transitions should be designed in accordance with the guidance drawings in Appendix B. The shoulders should be fully sealed and constructed with full depth pavement for 30m on the approach to the transition and continue to 50m after the end of the transition. This is to provide additional manoeuvre area for road users over the length of transition.

#### 4.5.2. Driveways and Accesses in the Transition Length

There should be no driveways or accesses in the Transition Length.

#### 4.5.3. Median Islands

A median island may be installed to highlight the start and the end of the treatment as shown in Appendix B Guideline Drawings.

Where a median island is installed, lighting should be provided to ensure visibility to the start and end of the treatment.

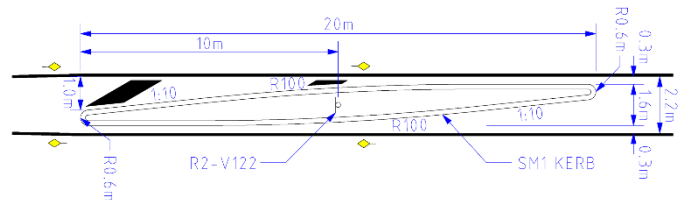

Median islands should be considered on greenfield projects, higher volume roads, and state significant routes.

Install a R2-V122 sign without an island as per Appendix B if it is considered that a median island is not appropriate for the site. This can be determined by the project team and region.

#### 4.6. Curve Widening and Vehicle Tracking

Curves within the project area will need to be assessed to determine whether any curve widening is required to accommodate the design vehicle for the design speed. Refer to AGRD Part 3 (2016), Section 7.9 Pavement Widening on Horizontal Curves. Curve widening should be incorporated into the project where required.

Where accesses will be restricted to left in and left out due to the introduction of a central barrier, the designer should check the appropriate vehicle turn path to ensure that each access is maintained.

#### 4.7. Combination of Minimum Design Values

Although Central Barrier in Narrow Medians are considered part of the Extended Design Domain, designers may consider implementing a Central Barrier in a Narrow Median with one other EDD parameter (i.e. reduced cross section width, reduced sight distance) as outlined in Austroads Guide to Road Design Part 3 Appendix A.

A combination of design minima should not be used (i.e. reduced sight distance, reduced lane widths and minimum barrier offset). Central Barrier in Narrow Median is one form of treatment to improve safety and should not be implemented without regarding the safety measures achieved through standard design practice (such as sight distance, cross section width).

In accordance with Safe System principles, a Central Barrier in Narrow Median should be installed with necessary geometric improvements to increase overall safety by creating a more forgiving road environment.

#### 4.8. Sight Distance

Sight distance requirements for the section of road need to be assessed for the design speed with reference to the VicRoads Supplements and the Austroads Guide to Road Design (specifically Part 3 and Part 4).

The designer should apply Normal Design Domain (NDD) values for sight distance wherever possible. Where NDD cannot be achieved, designers should follow the Extended Design Domain process in Austroads Guide to Road Design Part 3 Appendix A. Although Narrow Median Barriers are considered an EDD treatment, Narrow Median Barriers can be used in consideration with one other EDD parameter.

It is likely that the introduction of a central barrier in an existing road environment will have significant impacts on sight distance. The designer should follow the criteria found in Austroads Guide to Road Design Part 3 Section 5.5 “Sight Distance Requirements on Horizontal Curves with Roadside Barriers/Wall/Bridge Structures” to check whether sight distance is reduced by a central barrier. Experience shows that the criteria in this section provides acceptable sight distance for these circumstances. This supersedes the previous common practice of dismissing sight distance criteria altogether based on the grounds of being uneconomic.

If the horizontal alignment contains radii less than the values in the table below, it is likely that the implementation of a central barrier will reduce Stopping Sight Distance (SSD);

Design Speed	Minimum Radius <sup>(1)</sup> for 1.0m clearance to barrier (2.2m median)	Minimum Radius <sup>(1)</sup> for 3.0m clearance to barrier (6.2m median)
80km/h	450m	250m
90km/h	575m	350m
100km/h	875m	500m
110km/h	1050m	600m

Notes:

1. Radii assumes Manoeuvre Sight Distance (MSD) (i.e. presence of a 3.0m wide inner or outer shoulder). Refer AGRD Part 3 for other sight distance models available to be used for assessment of risk.
2. Ensure that appropriate superelevation is provided for radius adopted.

Designers should check the minimum radius for trucks<sup>11</sup> if there is a high number of trucks on the route. If the horizontal geometry contains radius less than the minimum radii in the table, designers should confirm whether SSD will be reduced through a sight distance analysis. The combination of horizontal and vertical geometry may also reduce SSD.

If SSD is reduced designers should follow the process found in AGRD Part 3 Appendix G “Flow Charts and Table for Determining Stopping Sight Distance Requirements for Curves with Barriers”.

Options for improving SSD or mitigating the reduction of SSD include;

- Widening the inside median shoulder to provide greater SSD
- Improving the geometry with larger horizontal curves to meet SSD, and greater vertical curves if required
- Providing Manoeuvre Sight Distance (MSD) through wider sealed shoulders (checking SSD for dry conditions)
- Reducing the speed

<sup>11</sup> See Austroads Guide to Road Design Part 3 Appendix G Table G 1

#### 4.9. Accesses and Intersections

The implementation of a central barrier in a narrow median may have an impact on sight distances for accesses and intersections (Wire Rope Safety Barrier is not see through and does obstruct sight lines). Designers should check that any impacts and changes to sight distance at intersections meet the requirements in Austroads Guide to Road Design Part 4A Section 3.2.

For sight distance requirements at accesses and property entrances designers should refer to Austroads Guide to Road Design Part 4A Section 3.4.

The project team should consider safety improvements and upgrades to intersections and accesses and coordinate the work or incorporate this into the project.

Any changes to accesses and intersections will need to take into consideration affected stakeholders and undertake engagement as required.

Access for all Heavy Vehicles and Over Dimensional (OD) vehicles identified in VicRoads Heavy Vehicle Map Networks in Victoria shall be provided as part of implementation of any road safety barrier strategy and should be checked with turn paths, particularly when verge barriers are being installed with a central barrier. Private properties may have specific vehicle access needs (for example, agricultural properties) which need to be considered.

#### 4.10. Road side hazards

Road side hazards will need to be considered as vehicles may be travelling closer to any existing hazards due to widening.

Verge vegetation may need to be trimmed or removed to improve sight lines and should be considered as part of the project.

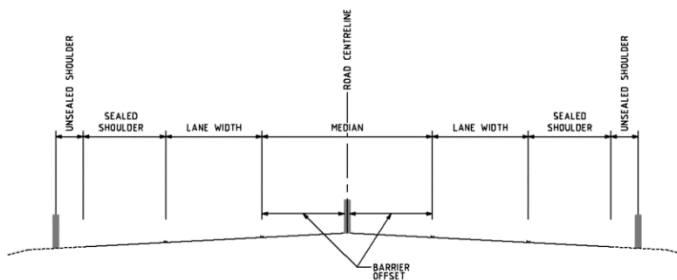

DESIGN CROSS SECTION WITH VERGE BARRIERS

Narrow median barriers may be installed in conjunction with verge barriers. However, this will need careful consideration as to how it may impact the operational requirements (including safety for emergency services) and roadside maintenance.

#### 4.10.1. Minimum Width between Barriers

The minimum width between barriers is based on the width to maintain safety of the road under all operational conditions. The minimum width for operational requirements may be determined by;

- Safe operation during events where emergency services are required
- Transportation of oversize loads and over dimensional loads eg. Both designated and undesignated Over Dimensional routes
- Special event management eg. Contraflow situations or events requiring additional lane capacity for special events
- Operational requirements during an emergency for the Country Fire Authority<sup>12</sup>

#### 4.11. Linemarking and Signing

Line marking and signing are to be implemented in accordance with the guidance drawings in Appendix B, Australian Standards and the VicRoads Traffic Engineering Manual.

##### 4.11.1. Audible Tactile Line Marking (ATLM)

Audible Tactile Line Marking (ATLM) for the median and lane line are to be installed for the length of treatment including the approach length in each direction. Considerations should be given to the proximity of residential properties when proposing Audible Tactile Line Marking.

##### 4.11.2. Approach Length Line Marking

Double Two-Way barrier line marking is to be installed for the Approach Length (See Section 4.5) to prohibit overtaking on the approach to the median transition.

##### 4.11.3. Chevron Line Marking

1m wide chevron line marking on sealed shoulders greater than 3m should be installed at a spacing of 40m and at an angle of 30 degrees in accordance with VicRoads Supplement to AS1472.2 Clause 5.5.1.3. This is to avoid the confusion that road users may assume that the sealed shoulder is an additional travel lane.

Chevron line marking in the median over the Transition Length (See Section 4.5.1) should be set out as below.

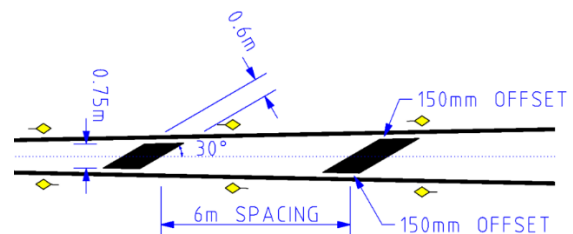

<sup>12</sup> The total minimum width between barriers is 8.1m (4m LHS offset, 3.5m lane, 0.6m RHS offset). Lesser widths (such as a reduced LHS shoulder of 3.0m) may be accepted subject to CFA's agreement.

#### 4.11.4. Line Marking over the Transition Length

Edge line and yellow unidirectional RRPM's at 6m spacing should be installed on the median edge over the transition length. Edge line and red unidirectional RRPM's at 6m spacing should be installed on the outside lane edge over the transition length. This is to provide greater deliniation over the transition length.

#### 4.11.5. Signing on Approach and End of Treatment

On the approach to the treatment, a W 4-4 sign with a W 8-5 sign should be installed at 500m and 200m before the start of the transition.

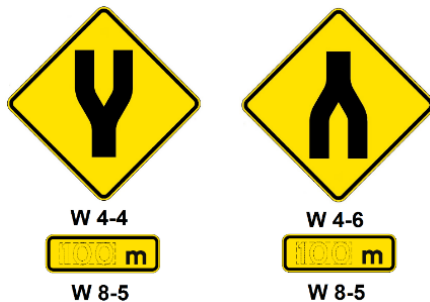

A W 4-6 with a W 8-5 sign should be installed 200m before the start of the transition at the end of the treatment.



A R2-V122 should be installed at the start of the treatment as well as where there is a significant break and recommencement of the central barrier such as at an intersection or large access.

Signing before the start and the end of treatment will make road users aware of the commencement and end of the treatment. Designers should follow the guidance in the drawings in Appendix B.

#### 4.12. Drainage

Drainage will need to be assessed to determine whether additional drainage is required. Pavement widening will increase the area of catchment so it is important to determine whether existing drainage is adequate.

Some barrier systems (for example concrete barrier) may have an impact on surface flow, particularly on horizontal curves where the road is in superelevation.

Existing culverts may need to be upgraded or extended as a result of widening.

## 5. Barrier Selection

Appropriate barrier selection must follow the process in VicRoads Supplement to the Austroads Guide to Road Design Part 6. In addition to this, specific considerations for central barriers in narrow medians are noted below.

### 5.1. Whole-of-life Costs

The whole-of-life costs are to be considered when selecting a barrier and the offsets to the barrier. The whole-of-life costs should take into account the frequency of hit and costs of maintenance and repair.

### 5.2. Considerations for Wire Rope Safety Barrier

Below are some considerations that influence selection of Wire Rope Safety Barrier (WRSB) over back to back Flexible Guard Fence (FGF);

- Higher containment than Flexible Guard Fence. This is of importance when there is a high percentage of Heavy Vehicles
- Less impacts on existing pavement when installed and impacted

### 5.3. Considerations for back-to-back Flexible Guard Fence

Below are some considerations that influence selection of back to back Flexible Guard Fence (FGF) over Wire Rope Safety Barrier (WRSB);

- FGF can sustain secondary impacts whereas WRSB may be disabled once hit (this can be important in remote areas where maintenance response/frequency may be challenging)
- WRSB cannot be installed on curve less than 200m radius
- FGF can incorporate forgiving motorcycle friendly options
- It does not have a minimum length of installation and does not require an overlap

### 5.4. Considerations for Concrete Barrier

Below are some considerations when selecting concrete barrier;

- The selection of Concrete Barrier Type F for a narrow median is to be considered only under highly constrained conditions as it is a rigid barrier and less forgiving for vehicle occupants.
- Concrete Barrier Type F can be used in conjunction with back to back Flexible Guard Fence
- Should be used in areas that require no deflection
- Impact on drainage, particularly on curves with superelevation
- Can be used in areas with higher numbers of motorcycles



- f) Reduced maintenance in constrained areas
- g) Higher containment for Heavy Vehicles. This is important when there is a high percentage of Heavy Vehicles
- h) Impact on drainage

### 5.5. End Terminals

Approved end terminals for narrow medians and back to back use found in [RDN 06-04](#) Accepted Safety Barrier Products are to be used.

At the time of publishing this document, the X-Tension terminal is the only product approved for back-to-back barrier use for Flexible Guard Fence.

Approved by



Daniel Cassar  
Manager Safe System Engineering

### Contact

For further information please contact:

VicRoads Technical Services  
60 Denmark St, Kew Vic 3101  
Email: safesystemengineering@roads.vic.gov.au

**Road Design Notes are subject to periodic review and may be superseded.**

### Road Design Note 03-08 – Revision Summary

Issue	Approved	Date	Amendment
03-08	M-SSE	June 2018	First edition

### Appendices

APPENDIX A: Design Parameters for Central Barrier in Narrow Medians

APPENDIX B: Guideline Drawings

## Appendix A: Design Parameters for Central Barrier in Narrow Medians

Designers and project teams should always consider implementing the “Minimum Recommended” and “Recommended Use” values first before selecting the “Highly Constrained Context” values. If the “Highly Constrained Context” values are used, evidence and justification for these values need to be documented in the Extended Design Domain and Design Exceptions report.

These tables have been based on the cross sections contained in VicRoads Supplement to AGRD Part 3 Figure V4.6 for Class, Volume and cross section widths. These cross sections may be updated and the project team is to adopt a best practice approach that aligns with Safe System principles, VicRoads current policies and publications.

Where Central Barrier is being implemented in conjunction with verge barrier, shoulder widths should be provided in accordance with offsets required for verge barriers in as outlined in Section 4.9 and the with the Region’s input.

For major infrastructure upgrades, the project team should always aim to adopt a median width of 6.2m in alignment with Normal Design Domain standards. **Where a median width of 6.2m cannot be implemented, a recommended median width of 4.2m should be adopted.**

**Table 1 – Wire Rope Safety Barrier (WRSB) and Flexible Guard Fence (FGF) in Narrow Medians**

	Road Class Volume	Total Width	Shoulder	Lane Width	Median	Lane Width	Shoulder	Comment
1.1	B or C <1500 AADT	9.6	1.0 (0.5 US + 0.5 SS)	3.1	1.4	3.1	1.0 (0.5 US + 0.5 SS)	Highly Constrained Context
1.2	B or C <1500 AADT	10.6-11.4	1.5 (1.0 US + 0.5 SS)	3.1	1.4-2.2	3.1	1.5 (1.0 US + 0.5 SS)	Minimum Recommended
1.3	B or C >1500 AADT	11.4	1.5 (0.5 US + 1.0 SS)	3.5	1.4	3.5	1.5 (0.5 US + 1.0 SS)	Highly Constrained Context
1.4	B or C >1500 AADT	12.4-13.2	2.0 (1.0 US + 1.0 SS)	3.5	1.4-2.2	3.5	2.0 (1.0 US + 1.0 SS)	Minimum Recommended
1.5	B or C >1500 AADT	13.2-16.2	2.0 (1.0 US + 1.0 SS)	3.5	2.2-6.2	3.5	2.0 (1.0 US + 1.0 SS)	Recommended
1.6	A <1500 AADT	10.6	1.5 (0.5 US + 1.0 SS)	3.1	1.4	3.1	1.5 (0.5 US + 1.0 SS)	Highly Constrained Context
1.7	A <1500 AADT	11.6-12.4	2.0 (0.5 US + 1.5 SS)	3.1	1.4-2.2	3.1	2.0 (0.5 US + 1.5 SS)	Minimum Recommended
1.8	A <1500 AADT	12.4-15.4	2.0 (0.5 US + 1.5 SS)	3.1	2.2-6.2	3.1	2.0 (0.5 US + 1.5 SS)	Recommended
1.9	A >1500 AADT	12.4	2.0 (0.5 US + 1.5 SS)	3.5	1.4	3.5	2.0 (0.5 US + 1.5 SS)	Highly Constrained Context
1.10	A >1500 AADT	13.4-14.2	2.5 (1.0 US + 1.5 SS)	3.5	1.4-2.2	3.5	2.5 (1.0 US + 1.5 SS)	Minimum Recommended
1.11	A >1500 AADT	14.2-17.2	2.5 (1.0 US + 1.5 SS)	3.5	2.2-6.2	3.5	2.5 (1.0 US + 1.5 SS)	Recommended

Note 1: A 3.0m left shoulder should adopted on major state highways

Note 2: Shoulder widths may be wider when central barrier is implemented in conjunction with verge barrier

Table 2 – Concrete Barrier Type F (CB-F) in Narrow Medians

	Road Class Volume	Total Width	Shoulder	Lane Width	Median	Lane Width	Shoulder	Comment
3.1	B or C <1500 AADT	11.0-11.8	1.5 (1.0 US + 0.5 SS)	3.1	1.8-2.6	3.1	1.5 (1.0 US + 0.5 SS)	Highly Constrained Context
3.2	B or C >1500 AADT	12.8-13.6	2.0 (1.0 US + 1.0 SS)	3.5	1.8-2.6	3.5	2.0 (1.0 US + 1.0 SS)	Highly Constrained Context
3.3	A <1500 AADT	12.0-12.8	2.0 (1.0 US + 1.0 SS)	3.1	1.8-2.6	3.1	2.0 (1.0 US + 1.0 SS)	Highly Constrained Context
3.4	A >1500 AADT	13.8-14.6	2.5 (1.0 US + 1.5 SS)	3.5	1.8-2.6	3.5	2.5 (1.0 US + 1.5 SS)	Highly Constrained Context

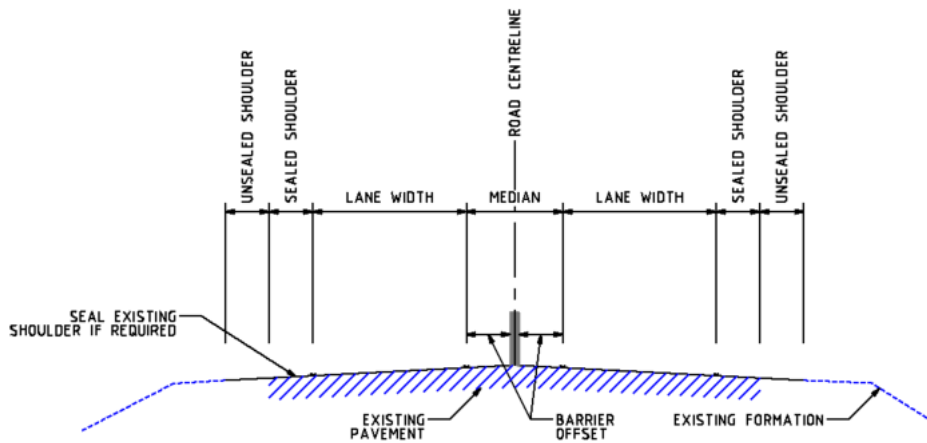

DESIGN CROSS SECTION WITHIN THE EXISTING PAVEMENT

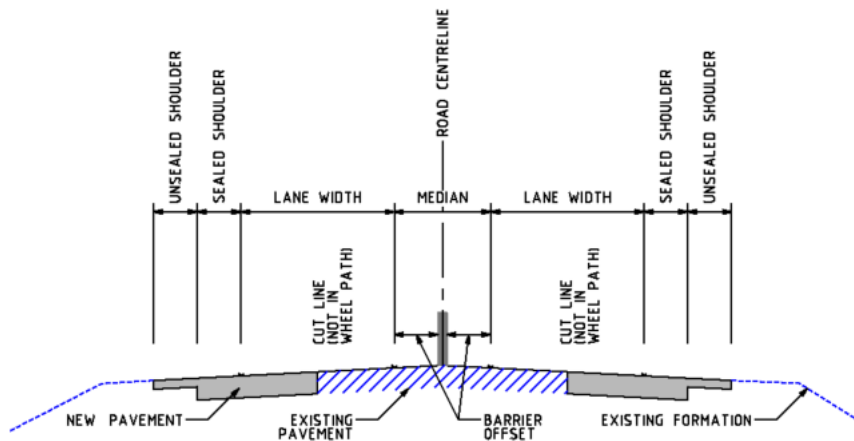

DESIGN CROSS SECTION WITH PAVEMENT WIDENING

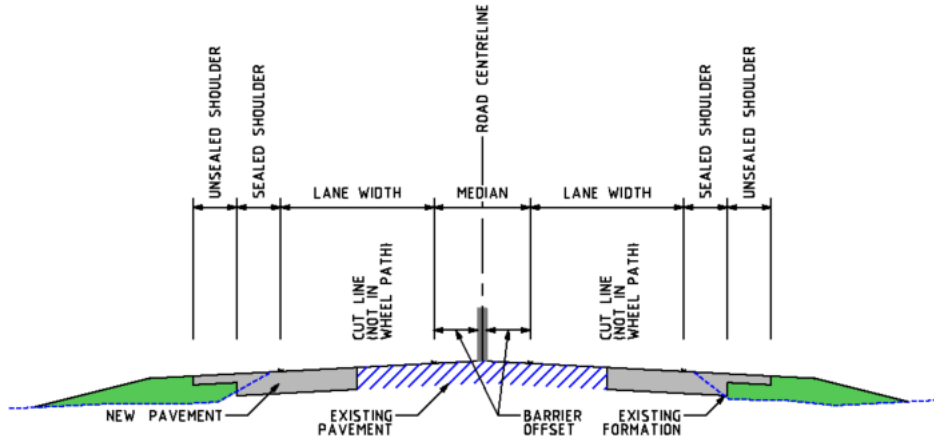

DESIGN CROSS SECTION WITH FORMATION AND PAVEMENT WIDENING

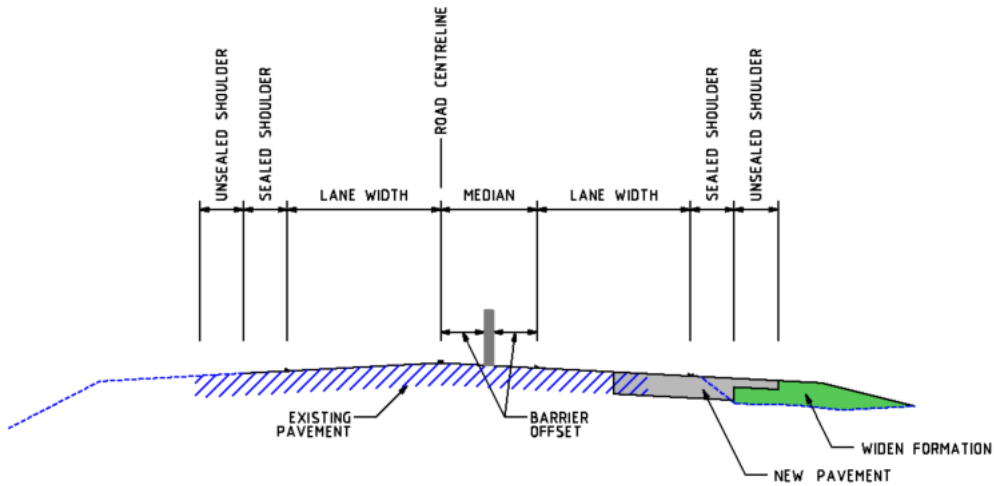

DESIGN CROSS SECTION WITH WIDENING ON ONE SIDE

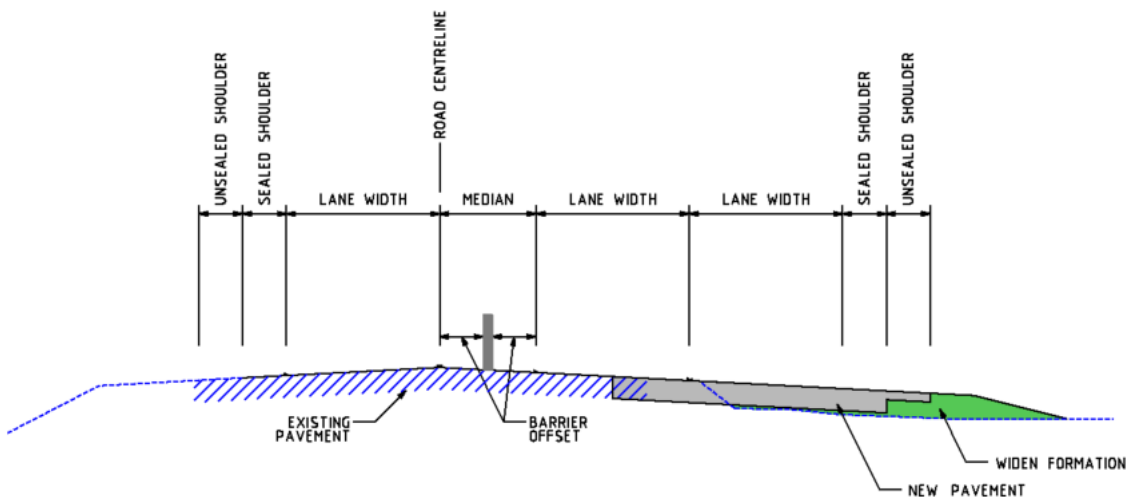

DESIGN CROSS SECTION WITH PAVEMENT WIDENING AND OVERTAKING LANE

## Appendix B: Guideline Drawings



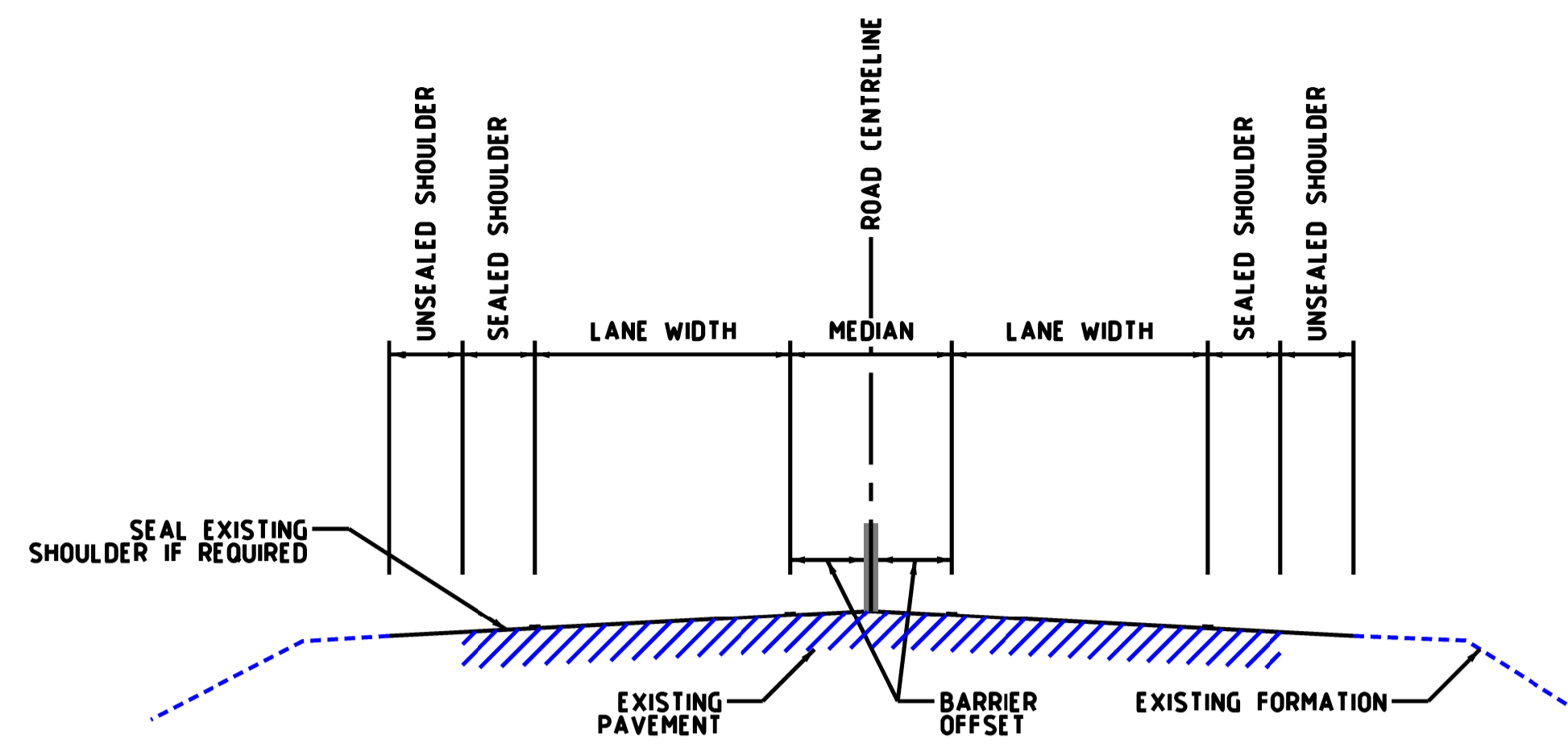

DESIGN CROSS SECTION WITHIN THE EXISTING PAVEMENT

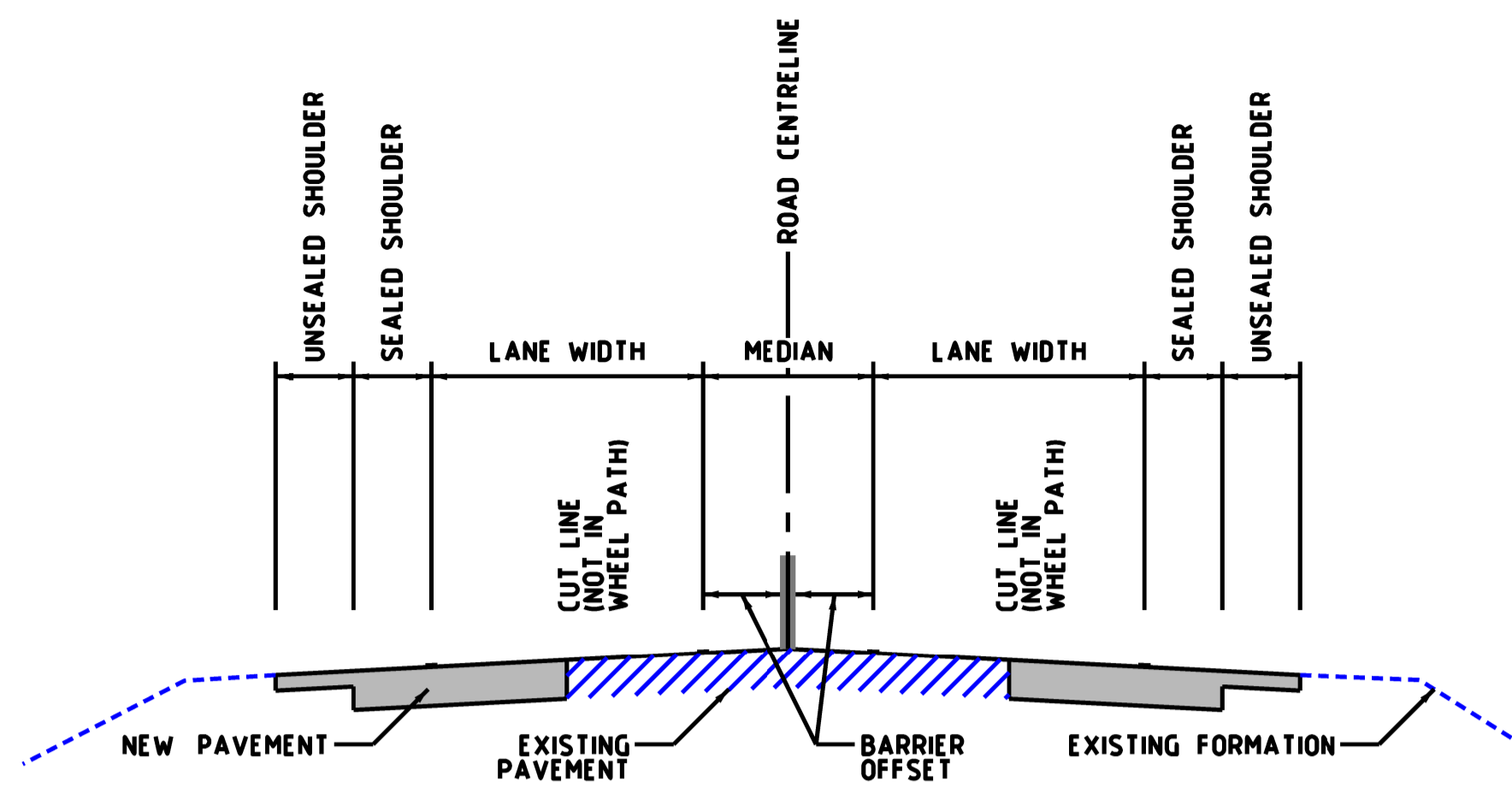

DESIGN CROSS SECTION WITH PAVEMENT WIDENING

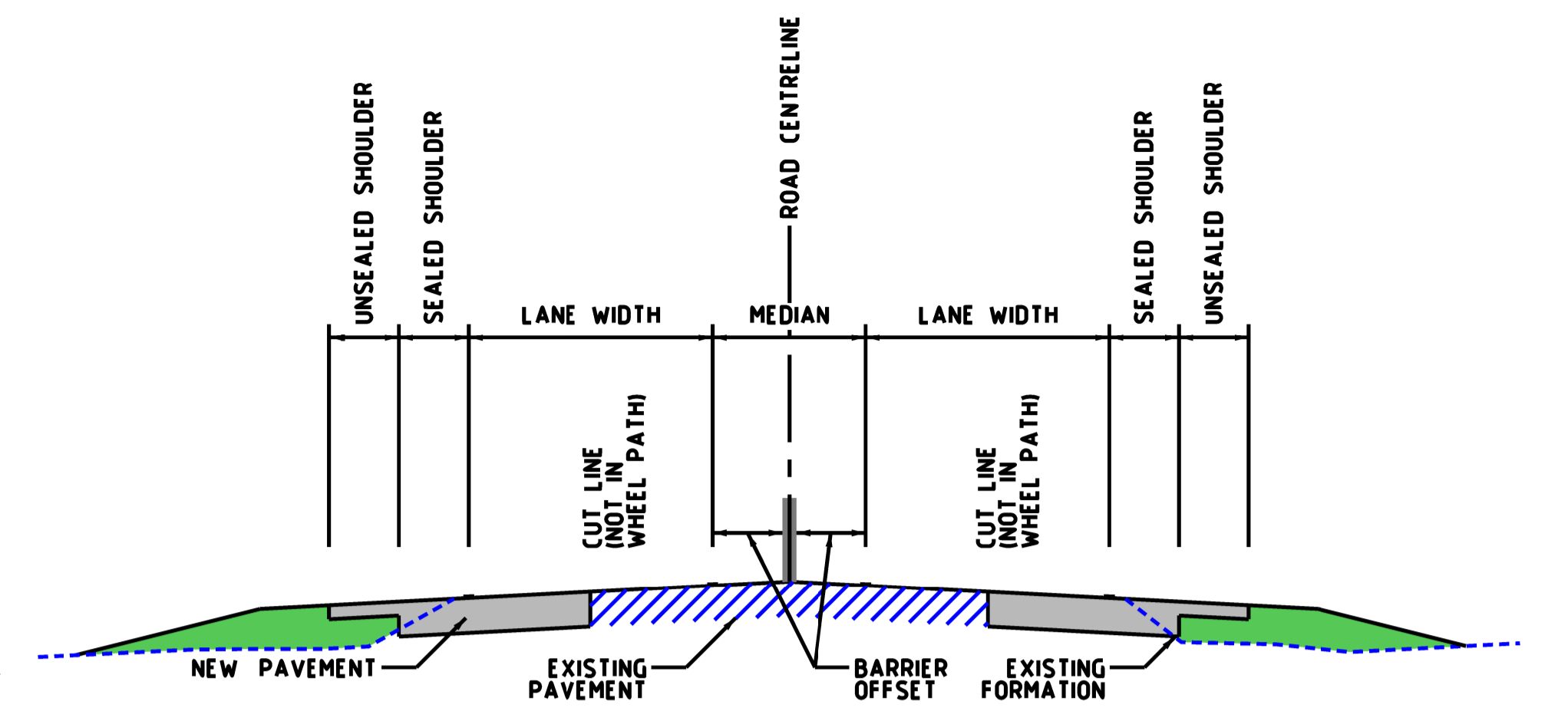

DESIGN CROSS SECTION WITH FORMATION AND PAVEMENT WIDENING

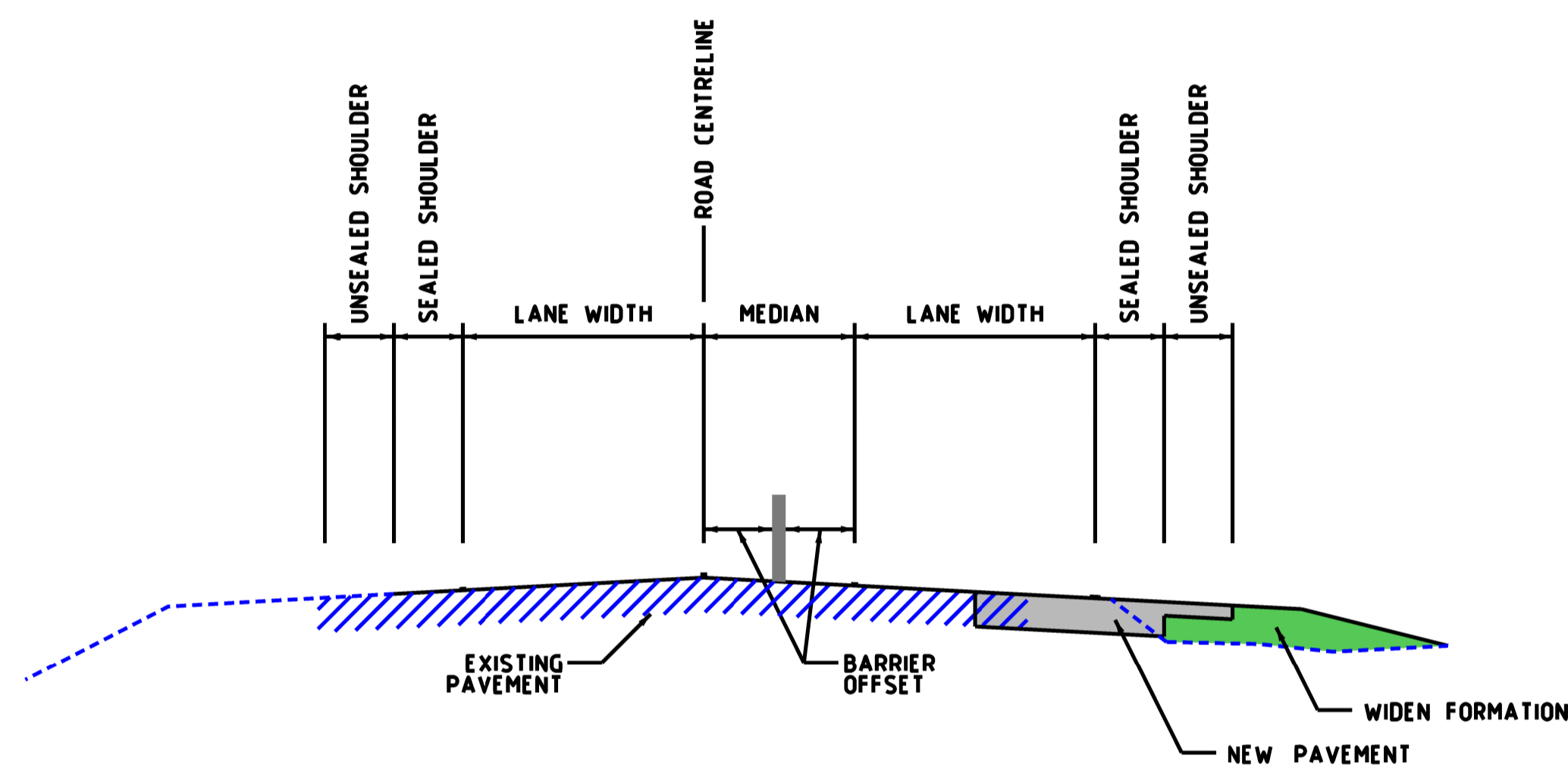

DESIGN CROSS SECTION WITH WIDENING ON ONE SIDE

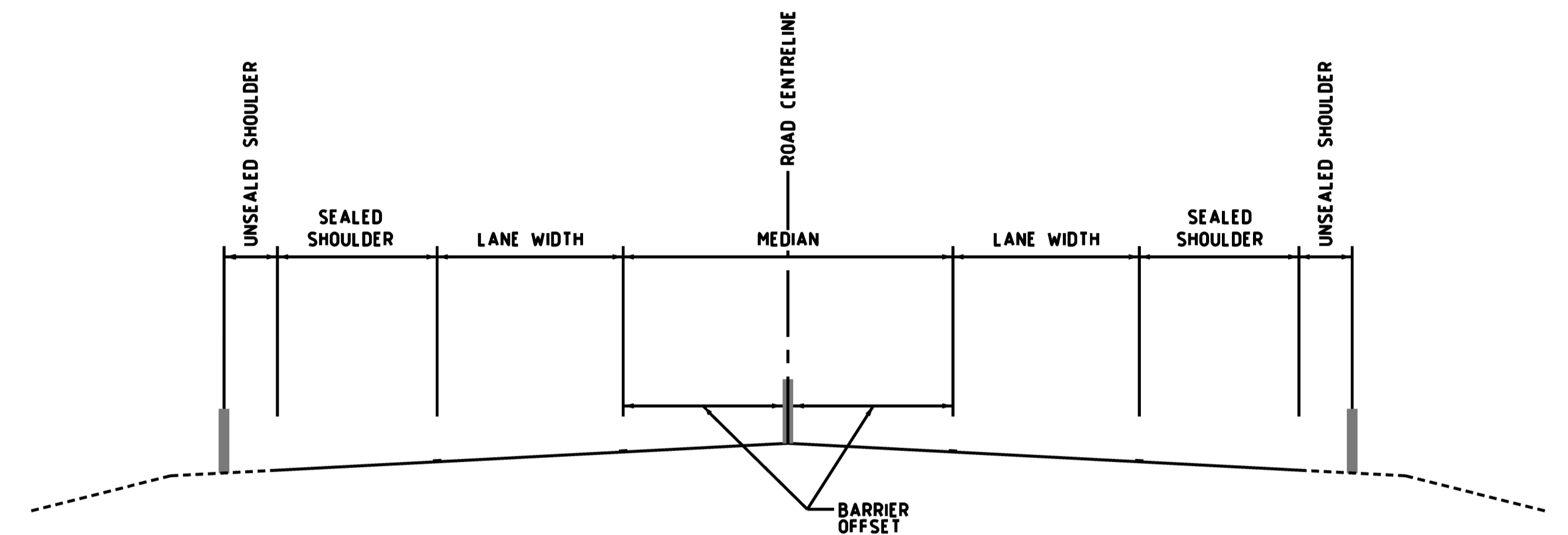

DESIGN CROSS SECTION WITH VERGE BARRIERS

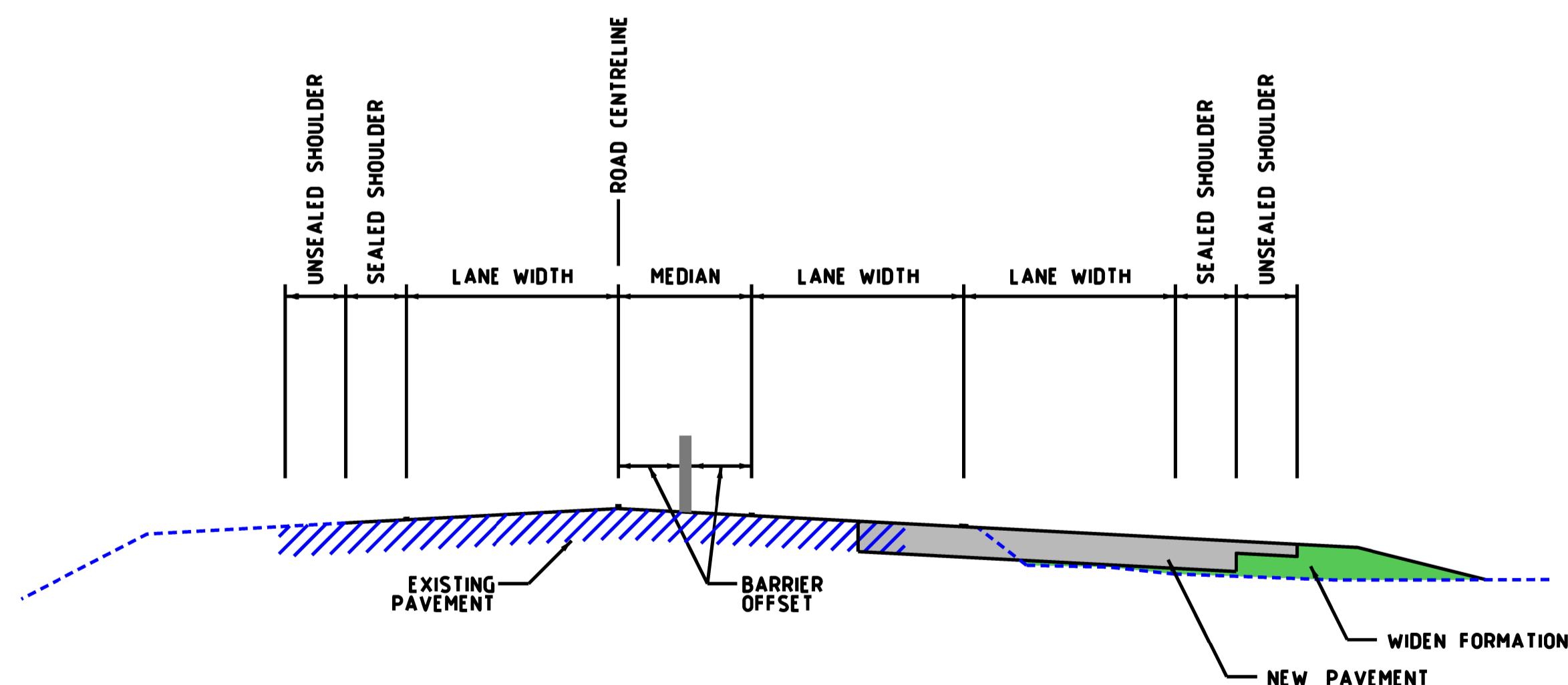

DESIGN CROSS SECTION WITH PAVEMENT WIDENING AND OVERTAKING LANE

Road Class	Volume	Total Width	Shoulder	Lane Width	Median	Lane Width	Shoulder	Comment
1.1	B or C <1500 AADT	9.6	1.0 (0.5 US + 0.5 SS)	3.1	1.4	3.1	1.0 (0.5 US + 0.5 SS)	Highly Constrained Context
1.2	B or C <1500 AADT	10.6-11.4	1.5 (1.0 US + 0.5 SS)	3.1	1.4-2.2	3.1	1.5 (1.0 US + 0.5 SS)	Minimum Recommended
1.3	B or C >1500 AADT	11.4	1.5 (0.5 US + 1.0 SS)	3.5	1.4	3.5	1.5 (0.5 US + 1.0 SS)	Highly Constrained Context
1.4	B or C >1500 AADT	12.4-13.2	2.0 (1.0 US + 1.0 SS)	3.5	1.4-2.2	3.5	2.0 (1.0 US + 1.0 SS)	Minimum Recommended
1.5	B or C >1500 AADT	13.2-16.2	2.0 (1.0 US + 1.0 SS)	3.5	2.2-6.2	3.5	2.0 (1.0 US + 1.0 SS)	Recommended
1.6	A <1500 AADT	10.6	1.5 (0.5 US + 1.0 SS)	3.1	1.4	3.1	1.5 (0.5 US + 1.0 SS)	Highly Constrained Context
1.7	A <1500 AADT	11.6-12.4	2.0 (0.5 US + 1.5 SS)	3.1	1.4-2.2	3.1	2.0 (0.5 US + 1.5 SS)	Minimum Recommended
1.8	A <1500 AADT	12.4-15.4	2.0 (0.5 US + 1.5 SS)	3.1	2.2-6.2	3.1	2.0 (0.5 US + 1.5 SS)	Recommended
1.9	A >1500 AADT	12.4	2.0 (0.5 US + 1.5 SS)	3.5	1.4	3.5	2.0 (0.5 US + 1.5 SS)	Highly Constrained Context
1.10	A >1500 AADT	13.4-14.2	2.5 (1.0 US + 1.5 SS)	3.5	1.4-2.2	3.5	2.5 (1.0 US + 1.5 SS)	Minimum Recommended
1.11	A >1500 AADT	14.2-17.2	2.5 (1.0 US + 1.5 SS)	3.5	2.2-6.2	3.5	2.5 (1.0 US + 1.5 SS)	Recommended

TABLE 1: CROSS SECTIONS FOR WIRE ROPE SAFETY BARRIER AND FLEXIBLE GUARD FENCE

Road Class	Volume	Total Width	Shoulder	Lane Width	Median	Lane Width	Shoulder	Comment
3.1	B or C <1500 AADT	11.0-11.8	1.5 (1.0 US + 0.5 SS)	3.1	1.8-2.6	3.1	1.5 (1.0 US + 0.5 SS)	Highly Constrained Context
3.2	B or C >1500 AADT	12.8-13.6	2.0 (1.0 US + 1.0 SS)	3.5	1.8-2.6	3.5	2.0 (1.0 US + 1.0 SS)	Highly Constrained Context
3.3	A <1500 AADT	12.0-12.8	2.0 (1.0 US + 1.0 SS)	3.1	1.8-2.6	3.1	2.0 (1.0 US + 1.0 SS)	Highly Constrained Context
3.4	A >1500 AADT	13.8-14.6	2.5 (1.0 US + 1.5 SS)	3.5	1.8-2.6	3.5	2.5 (1.0 US + 1.5 SS)	Highly Constrained Context

TABLE 2: CROSS SECTIONS FOR CONCRETE BARRIER TYPE F

GENERAL NOTES  
1. THIS DRAWING IS TO BE READ WITH VICROADS RDN 03-08 CENTRAL BARRIER IN NARROW MEDIANS

INVESTMENT AND DESIGN SERVICES  
NETWORK DESIGN SERVICES  
60 DENMARK STREET  
NEW VICTORIA 3101  
PHONE (03) 8391 7160



GUIDELINE DRAWING

CENTRAL BARRIER IN NARROW MEDIANS

TYPICAL CROSS SECTIONS AND DESIGN PARAMETERS

NOT TO SCALE APPROVED D. CASSAR 29/06/18 DRAWING NO. RDN-0308-01 ISSUE A

SDATES \$MODELNAME\$ \$FILES\$

ISSUE	APP'D	DATE	AMENDMENT
E			
D			
C			
B			
A	D.C.	290618	FIRST PUBLICATION

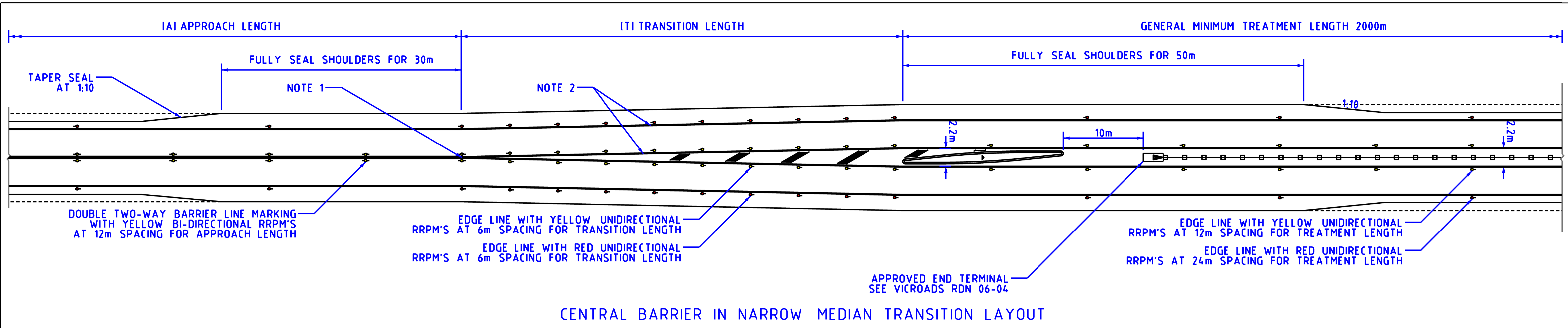

CENTRAL BARRIER IN NARROW MEDIAN TRANSITION LAYOUT

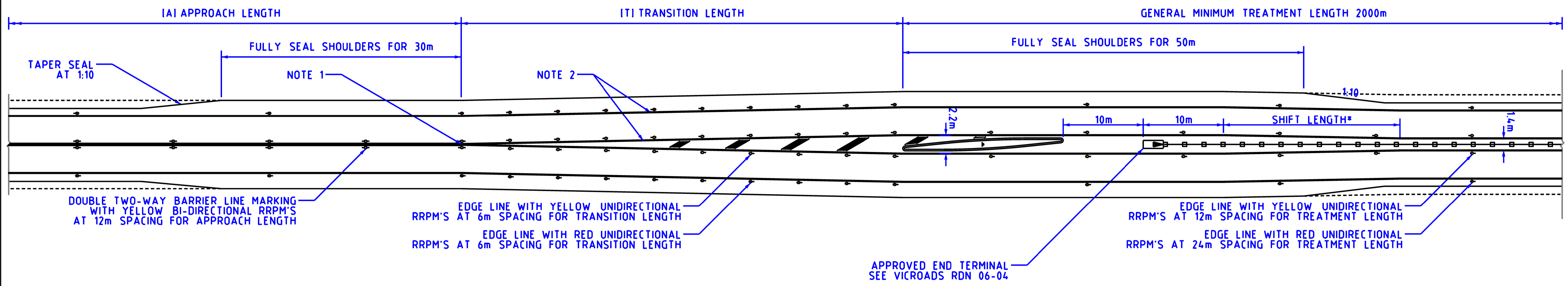

CENTRAL BARRIER IN NARROW MEDIAN TRANSITION LAYOUT (WITH LATERAL SHIFT TO NARROWER CROSS SECTION)

\*SHIFT LENGTH = 0.5VW  
(V - SPEED; W - LATERAL SHIFT WIDTH)

IAI APPROACH LENGTH	
SPEED	LENGTH
80km/h	135m
90km/h	150m
100km/h	170m
110km/h	185m

ITI TRANSITION LENGTH	
SPEED	LENGTH
80km/h	45m
90km/h	50m
100km/h	55m
110km/h	60m

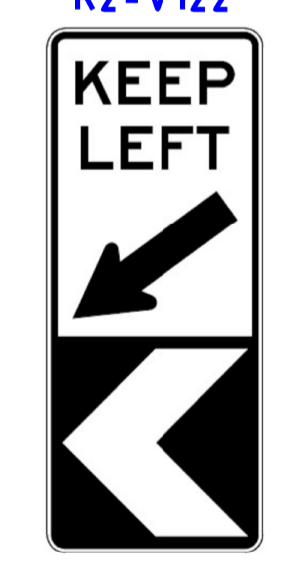
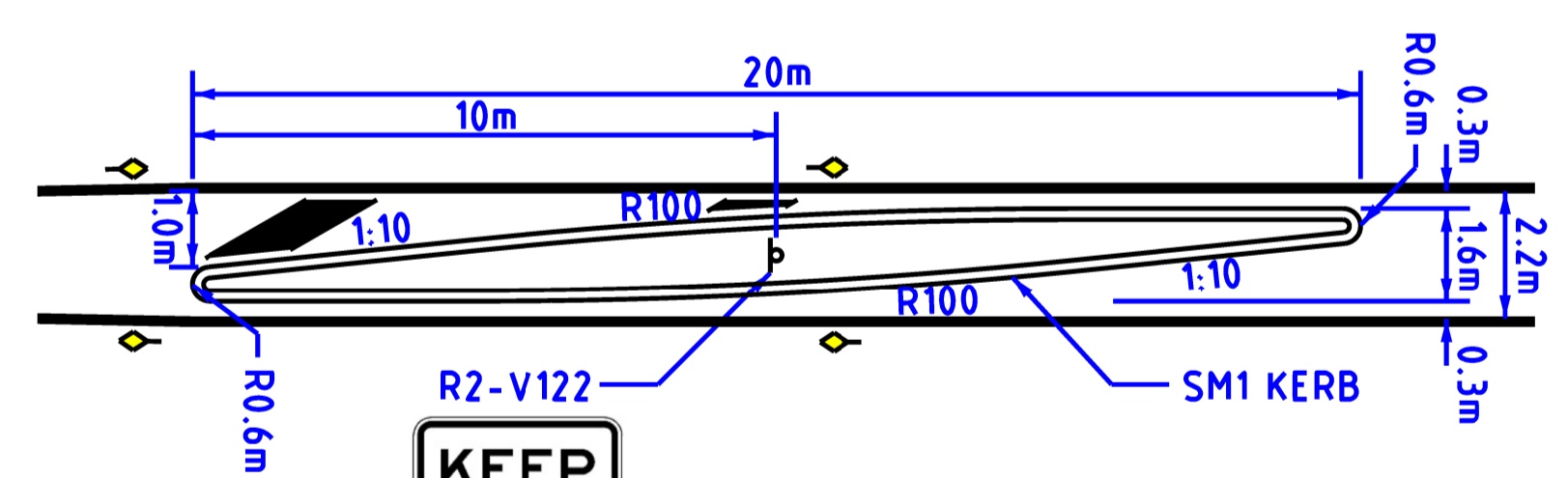

ISLAND SETOUT



INSTALL W 4-4 WITH W 8-5 500m AND 200m ON THE APPROACH LENGTH BEFORE THE START OF THE TRANSITION



INSTALL W 4-6 WITH W 8-5 200m BEFORE THE START OF THE TRANSITION AT THE END OF TREATMENT

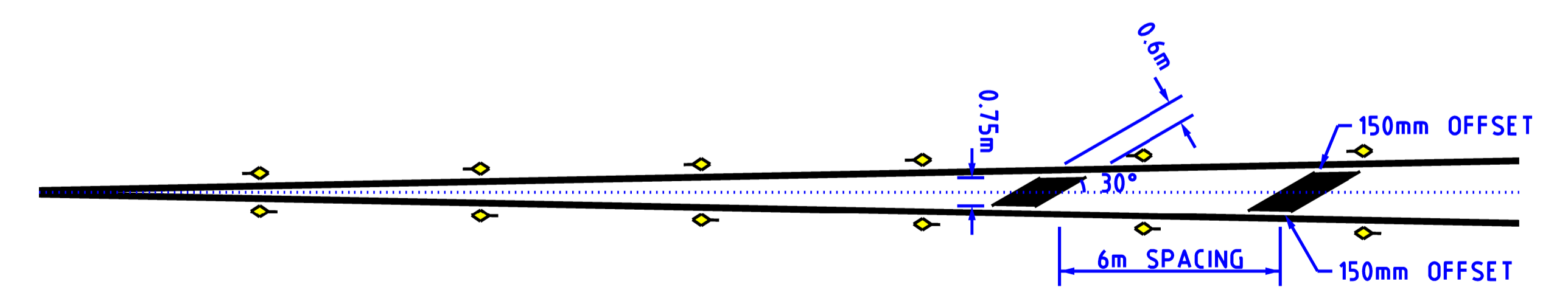

CHEVRON SETOUT

SDATES \$MODEL\$NAMES \$FILES\$

ISSUE	APP'D	DATE	AMENDMENT
E			
D			
C			
B			
A	D.C.	290618	FIRST PUBLICATION

**GENERAL NOTES**

- APPROACH SIGHT DISTANCE (ASD) FOR APPROACH DIRECTION REQUIRED TO START OF TREATMENT
- AUDIO-TACTILE EDGE LINE FOR LINEMARKING ON THE APPROACH, TRANSITION AND LENGTH OF TREATMENT
- THIS DRAWING IS TO BE READ WITH VICROADS RDN 03-08 CENTRAL BARRIER IN NARROW MEDIANS
- TRANSITION LENGTH IS NOT TO INCLUDE DRIVEWAYS OR PROPERTY ACCESSES
- INSTALL LIGHTING IN THE TRANSITION LENGTH TO HIGHLIGHT THE START AND END OF TREATMENT AND PROVIDE VISIBILITY TO THE MEDIAN ISLAND
- ONLY APPROVED PRODUCTS TO BE USED FOR MEDIAN BARRIER AND END TERMINAL.

SEE VICROADS RDN 06-04 ACCEPTED SAFETY BARRIER PRODUCTS.

INVESTMENT AND DESIGN SERVICES  
NETWORK DESIGN SERVICES  
60 DENMARK STREET  
K'EV  
VICTORIA 3101  
PHONE (03) 8391 7160



GUIDELINE DRAWING

CENTRAL BARRIER IN NARROW MEDIANS  
TRANSITION LAYOUT FOR 1.4m AND 2.2m MEDIAN WITH ISLAND

NOT TO SCALE	APPROVED D. CASSAR	29/06/18	DRAWING NO. RDN-0308-02	ISSUE A
--------------	-----------------------	----------	----------------------------	------------



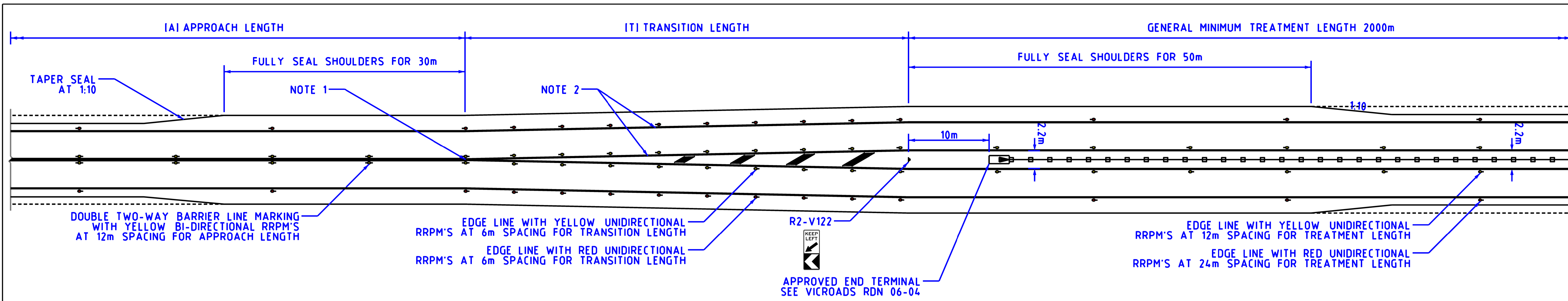

CENTRAL BARRIER IN NARROW MEDIAN TRANSITION LAYOUT

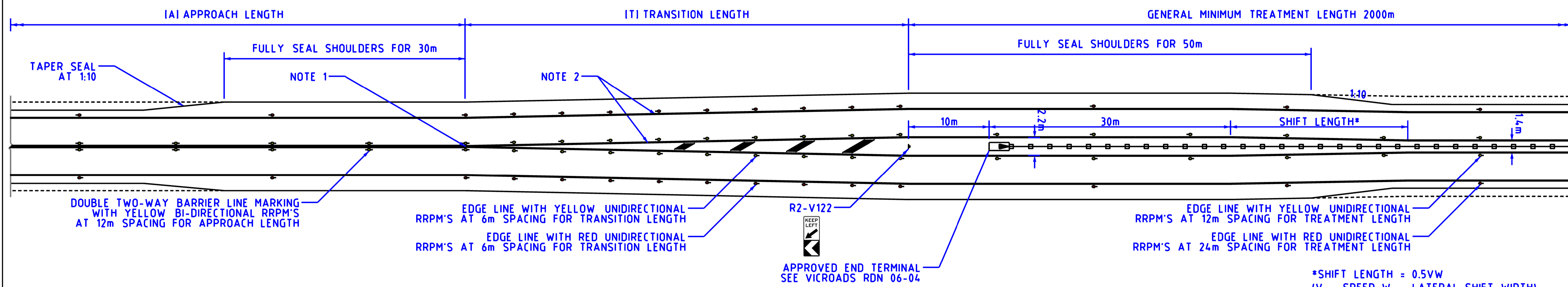

CENTRAL BARRIER IN NARROW MEDIAN TRANSITION LAYOUT  
(WITH LATERAL SHIFT TO NARROWER CROSS SECTION)

\*SHIFT LENGTH = 0.5VW  
(V - SPEED; W - LATERAL SHIFT WIDTH)



W 4-4  
W 8-5

INSTALL W 4-4 WITH W 8-5  
500m AND 200m ON THE  
APPROACH LENGTH BEFORE THE  
START OF THE TRANSITION



W 4-6  
W 8-5

INSTALL W 4-6 WITH W 8-5  
200m BEFORE THE START OF  
THE TRANSITION AT THE END  
OF TREATMENT

IAI APPROACH LENGTH	
SPEED	LENGTH
80km/h	135m
90km/h	150m
100km/h	170m
110km/h	185m

ITI TRANSITION LENGTH	
SPEED	LENGTH
80km/h	45m
90km/h	50m
100km/h	55m
110km/h	60m

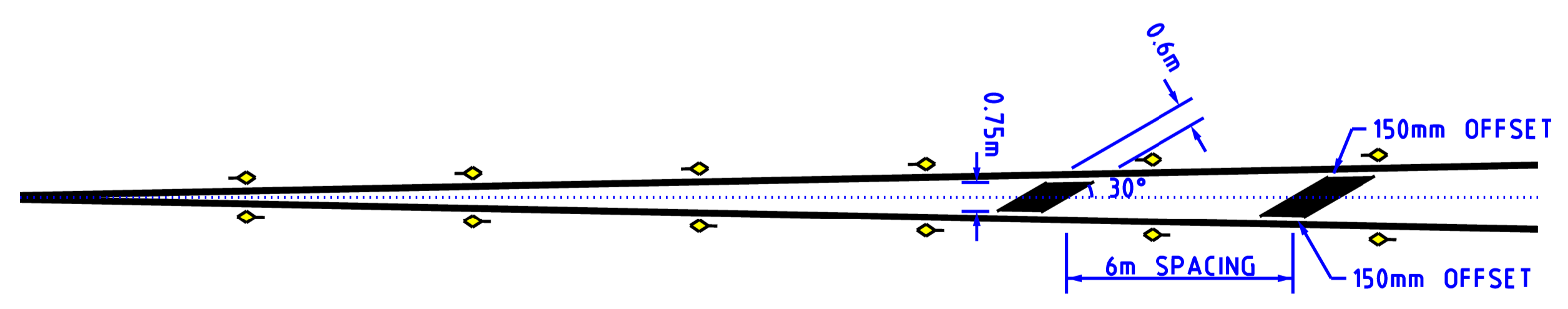

CHEVRON SETOUT

SDATES \$MODELNAMES \$FILES \$TIMES

ISSUE	APP'D	DATE	AMENDMENT
A	D.C.	290618	FIRST PUBLICATION

GENERAL NOTES

1. APPROACH SIGHT DISTANCE (ASD) FOR APPROACH DIRECTION REQUIRED TO START OF TREATMENT
2. AUDIO-TACTILE EDGE LINE FOR LINEMARKING ON THE APPROACH, TRANSITION AND LENGTH OF TREATMENT
3. THIS DRAWING IS TO BE READ WITH VICROADS RDN 03-08 CENTRAL BARRIER IN NARROW MEDIANS
4. TRANSITION LENGTH IS NOT TO INCLUDE DRIVEWAYS OR PROPERTY ACCESSES
5. INSTALL LIGHTING IN THE TRANSITION LENGTH TO HIGHLIGHT THE START AND END OF TREATMENT AND PROVIDE VISIBILITY TO THE MEDIAN ISLAND
6. ONLY APPROVED PRODUCTS TO BE USED FOR MEDIAN BARRIER AND END TERMINAL.

SEE VICROADS RDN 06-04 ACCEPTED SAFETY BARRIER PRODUCTS.

INVESTMENT AND DESIGN SERVICES  
NETWORK DESIGN SERVICES  
60 DENMARK STREET  
KEW  
VICTORIA 3101  
PHONE (03) 8391 7160



CENTRAL BARRIER IN NARROW MEDIANS TRANSITION LAYOUT FOR 1.4m AND 2.2m MEDIAN WITHOUT ISLAND			
NOT TO SCALE	APPROVED D. CASSAR	29/06/18	DRAWING NO. RDN-0308-03 ISSUE A

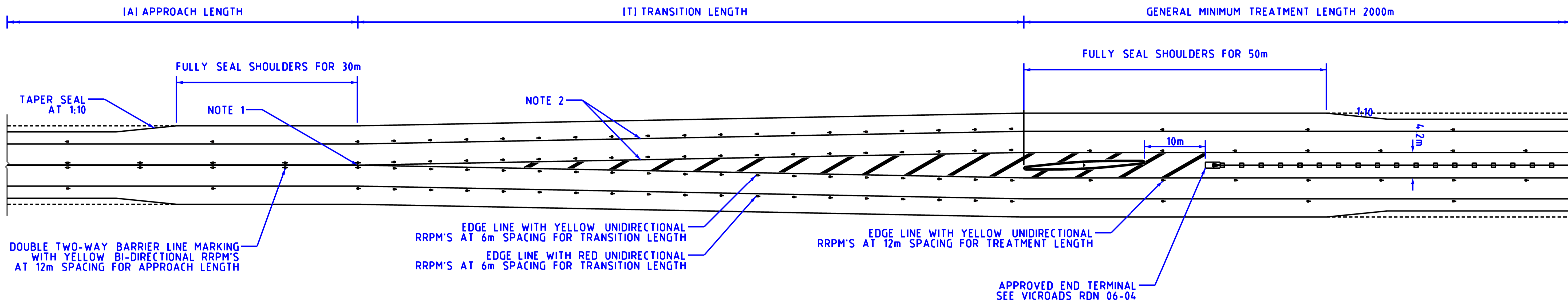

DOUBLE TWO-WAY BARRIER LINE MARKING WITH YELLOW BI-DIRECTIONAL RRPM'S AT 12m SPACING FOR APPROACH LENGTH

EDGE LINE WITH YELLOW UNIDIRECTIONAL RRPM'S AT 6m SPACING FOR TRANSITION LENGTH  
 EDGE LINE WITH RED UNIDIRECTIONAL RRPM'S AT 6m SPACING FOR TRANSITION LENGTH

EDGE LINE WITH YELLOW UNIDIRECTIONAL RRPM'S AT 12m SPACING FOR TREATMENT LENGTH

APPROVED END TERMINAL SEE VICROADS RDN 06-04

IAI APPROACH LENGTH	
SPEED	LENGTH
80km/h	135m
90km/h	150m
100km/h	170m
110km/h	185m

ITI TRANSITION LENGTH	
SPEED	LENGTH
80km/h	80m
90km/h	90m
100km/h	100m
110km/h	110m



INSTALL W 4-4 WITH W 8-5 500m AND 200m ON THE APPROACH LENGTH BEFORE THE START OF THE TRANSITION



INSTALL W 4-6 WITH W 8-5 200m BEFORE THE START OF THE TRANSITION AT THE END OF TREATMENT

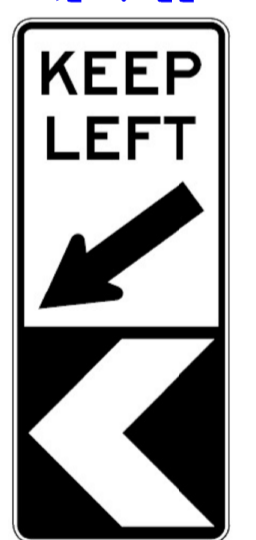
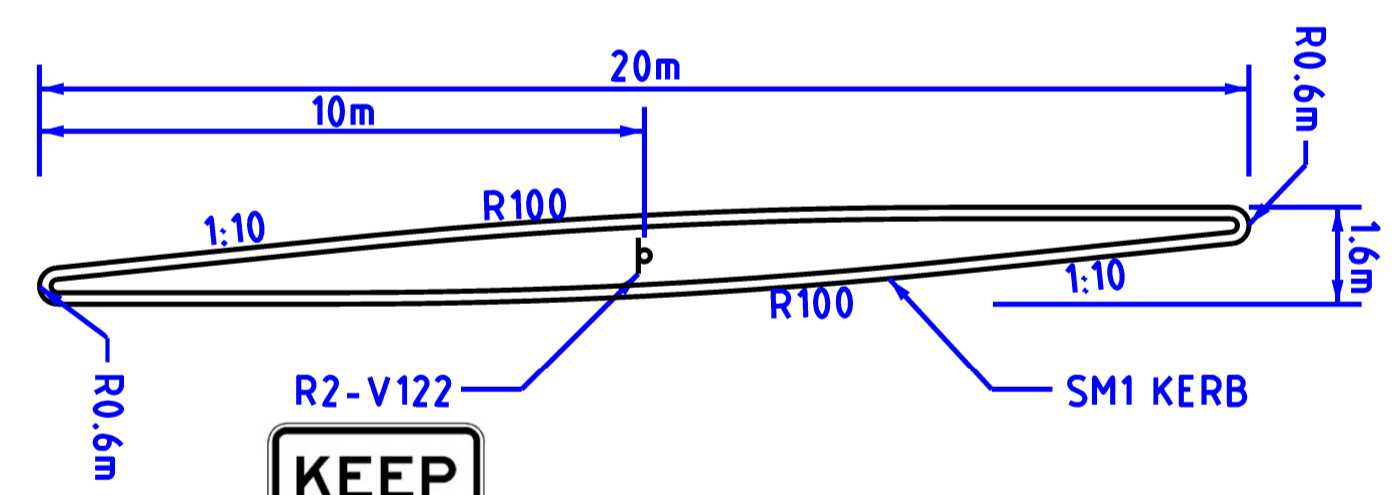

ISLAND SETOUT

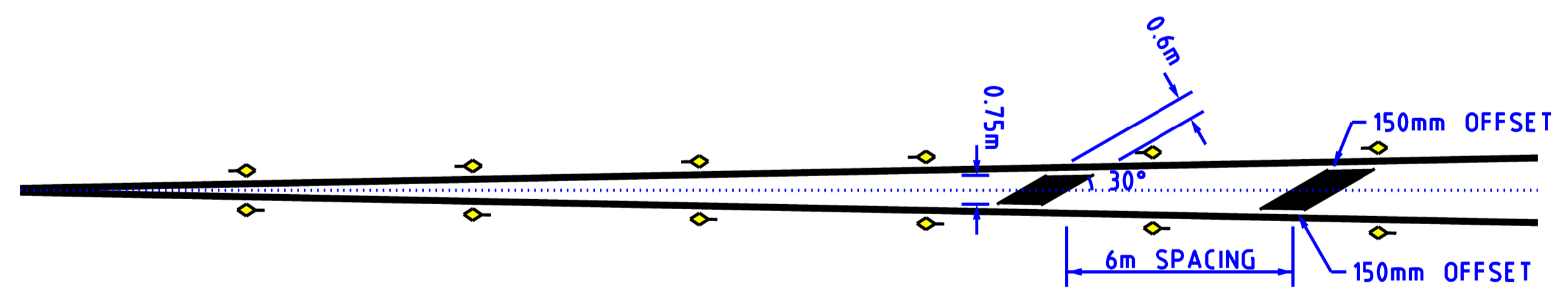

CHEVRON SETOUT

SDATES \$MODEL\$NAMES \$FILES\$

ISSUE	APP'D	DATE	AMENDMENT
A	D.C.	290618	FIRST PUBLICATION
B			
C			
D			
E			

**GENERAL NOTES**

1. APPROACH SIGHT DISTANCE (ASD) FOR APPROACH DIRECTION REQUIRED TO START OF TREATMENT
2. AUDIO-TACTILE EDGE LINE FOR LINEMARKING ON THE APPROACH, TRANSITION AND LENGTH OF TREATMENT
3. THIS DRAWING IS TO BE READ WITH VICROADS RDN 03-08 CENTRAL BARRIER IN NARROW MEDIANS
4. TRANSITION LENGTH IS NOT TO INCLUDE DRIVEWAYS OR PROPERTY ACCESSES
5. INSTALL LIGHTING IN THE TRANSITION LENGTH TO HIGHLIGHT THE START AND END OF TREATMENT AND PROVIDE VISIBILITY TO THE MEDIAN ISLAND
6. ONLY APPROVED PRODUCTS TO BE USED FOR MEDIAN BARRIER AND END TERMINAL.

SEE VICROADS RDN 06-04 ACCEPTED SAFETY BARRIER PRODUCTS.

INVESTMENT AND DESIGN SERVICES  
 NETWORK DESIGN SERVICES  
 60 DENMARK STREET  
 KEW  
 VICTORIA 3101  
 PHONE (03) 8391 7160



CENTRAL BARRIER IN NARROW MEDIANS			
TRANSITION LAYOUT FOR 4.2m MEDIAN WITH ISLAND			
NOT TO SCALE	APPROVED D. CASSAR	29/06/18	DRAWING NO. RDN-0308-04
			ISSUE A